

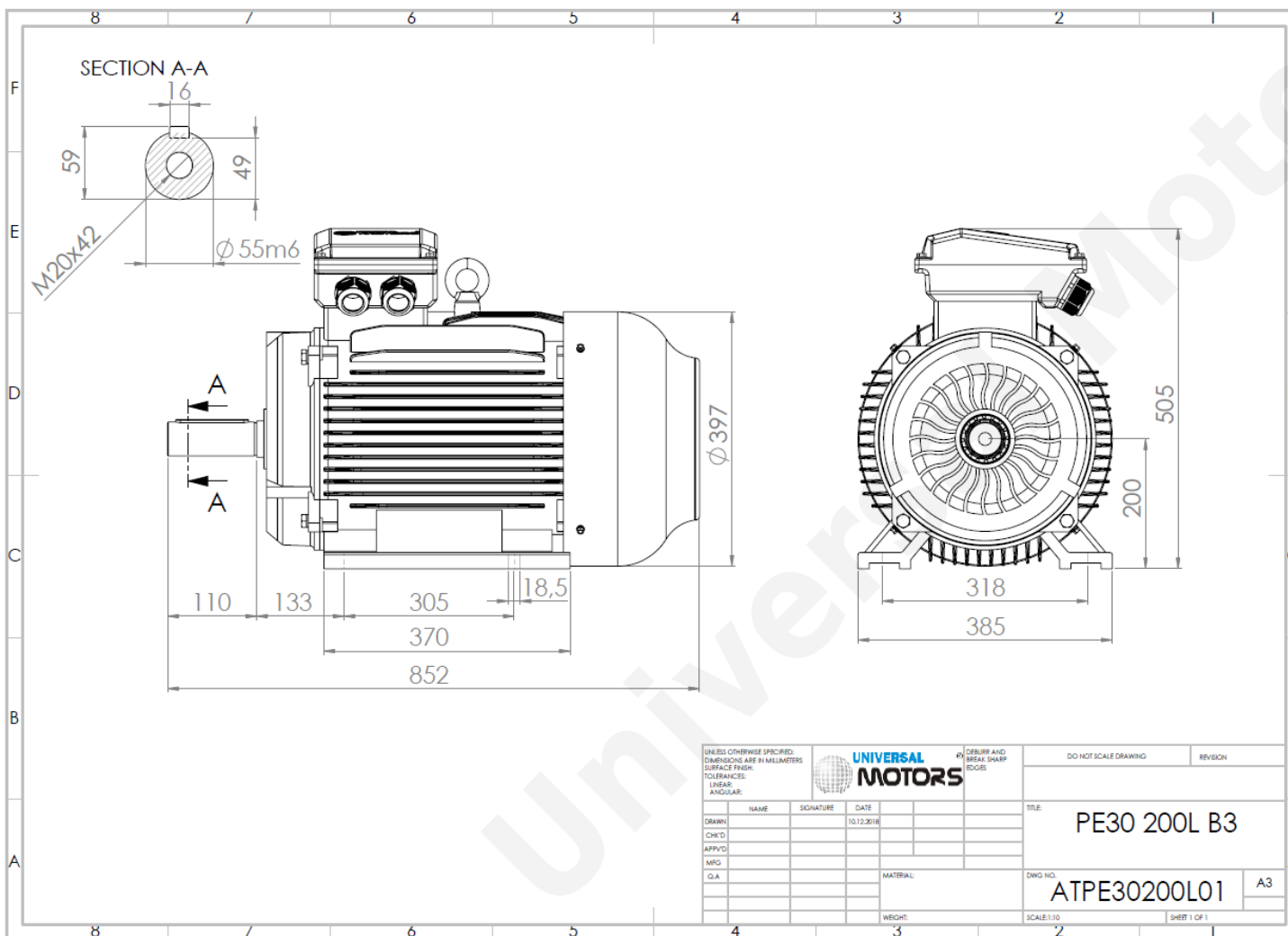

TECHNICAL DATA

Three Phase Electric Motors - Cast Iron Frame
 PE30 200 L1 2 IE3
 30 kW / 40 Cv
 2970 RPM



Motor type:	PE30 200 L1 2 IE3
Output:	30 kW / 40 Cv
Speed (min ⁻¹):	2970 RPM
Frequency:	50 Hz
Voltage:	400 V
Current:	52.1 A
Power factor (Cos ϕ):	0.89
Poles:	2
Insulation class:	F
Temperature rise Class:	B
Efficiency 50%:	92.2 %
Efficiency 75%:	93.6 %
Efficiency 100%:	93.4 %
Torque:	96 N.m
Tstarting/Tnominal:	2.0
Istarting/Inominal:	7.6
Tmaximum/Tnominal:	2.3
Noise:	84 Db(A)
Weight:	256 Kg
Bearing DE:	6312 C3
Bearing NDE:	6312 C3

Regime - S1

Altitude - 1000m

Environment Temperature - 40°C

CONTACTS:

UNIVERSAL MOTORS Tel: +351 252 299 080
 Rua de São Brás,745 Fax: +351 252 299 089
 4480-782 VILA DO CONDE Mail: geral@universalmotors.pt

* References applied only in the UK